

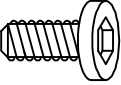





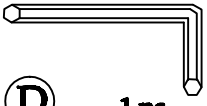

Components and Hardware List

M5/16" x 3/4" Allen Head Bolt  (A) 8 pcs.	5/16" Spring Washer  (B) 8 pcs.	5/16" x 18mm Flat Washer  (C) 8 pcs.	5mm Allen Wrench  (D) 1 pc.
5/16" Nut  (E) 1 pc.	Finial  (F) 1 pc.	Table Top  (G) 4 pcs.	Back Legs  (H) 1 pc.
Left Front Leg  (I) 1 pc.	Right Front Leg  (J) 1 pc.		

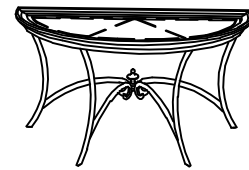

9715 sofa table

Be sure to check all packing material carefully for small parts, which may have come loose inside the carton during shipment.

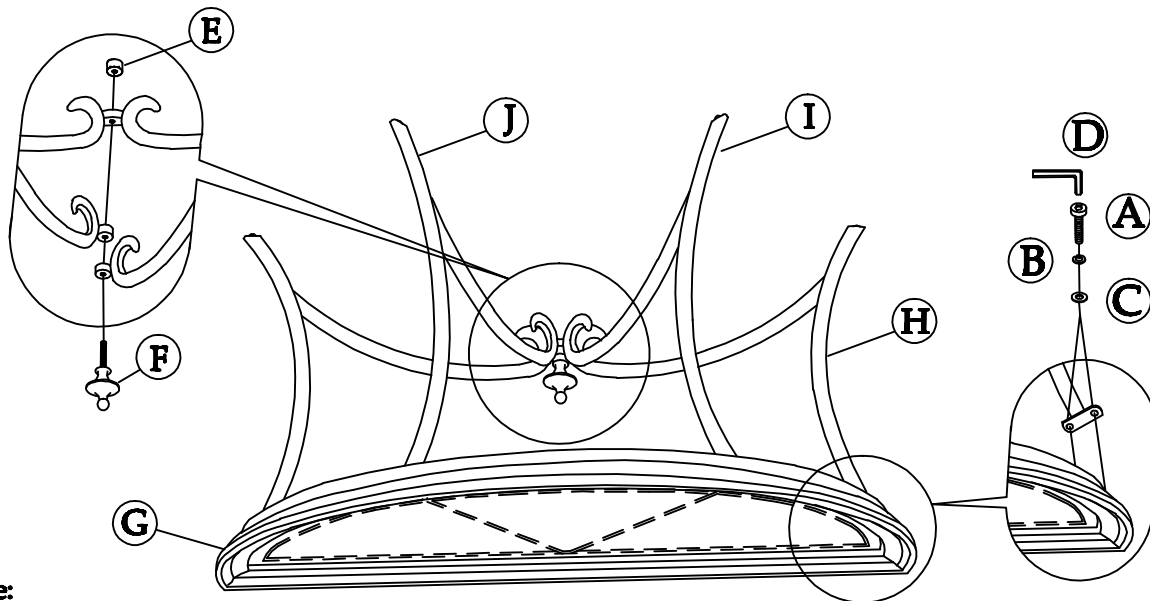

Note:

1. To prevent possible scratches or damage, assemble the Table upside down on a soft surface such as a blanket or carpet.
2. Attach the Back Legs (H) to the Table Top (G) using Allen Head Bolts (A), Spring Washers (B), and Flat Washers (C). Do not fully tighten until after Step #4.
3. Attach the Left Front Leg (I) and Right Front Leg (J) to the Top (G) using Allen Head Bolts (A), Spring Washers (B), and Flat Washers (C). Do not fully tighten until after next step.
4. Position the ring-tab on the back end of the Left and Right Front Leg with the Back Leg. Insert the bolt of the Finial (F) through the ring-tabs of all three parts and use the Nut (E) to connect the parts together and hand-tighten.
5. Tighten all bolts using the Allen Wrench (D) provided.
6. Carefully turn the Table upright.

If required, the table can be adjusted using the levelers on the bottom of the Legs.